

Instructions

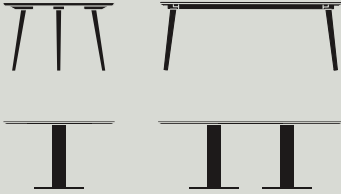

In Between Tables

Sami Kallio

2014

Congratulations on choosing this original In Between table, designed in 2014 by Sami Kallio. We hope you will enjoy using this product and follow these instructions to ensure correct assembly. If you have any questions or comments, please do not hesitate to contact us by mail on:

info@andtradition.com

Table of content

- 3 Safety precautions and cleaning instructions
- 6 Round and square table top with wooden legs SK3-SK4
- 7 Rectangular table top with wooden legs SK5-SK6
- 9 Round and square table top with center base SK16-SK17 & SK21-SK22
- 12 Round and square table top with round base SK11-SK12 & SK18-SK20

Please read these instructions carefully and retain them for future reference to ensure that the table is used correctly. For your own safety, please study each step of this instruction manual. &Tradition is not responsible for any faults or damages caused by not following these instructions correctly. Do not modify this product in any way.

Safety precautions

- Dispose of plastic bag from packaging and do not allow children to play with it.
- The table is only intended for interior use.
- Handle table tops with care in order not to scratch surfaces.
- Power tools can be used to assemble the table. Be careful not to overtighten or damage screw or thread.
- Two or more persons are needed to turn the table around once assembled.
- Spilled liquids of any kind should be removed immediately from the table top as it may penetrate the surface treatment and cause damage to it.

Cleaning instructions

Lacquered wood

For daily care it is recommended to dust the furniture with a soft cloth. Lacquered wood can be cleaned with a soft cloth wrung in a mild solution of lukewarm water and a universal cleaning detergent. Always follow the wood grains and always dry with a soft dry cloth immediately after cleaning. Avoid use of abrasive cleaning agents and aggressive cleaning detergents as this will damage the surface of the lacquered wood.

Laminate

Laminate is a hard-wearing and maintenance free material used for table tops in the &Tradition collection. Laminate can be cleaned with a soft cloth wrung in a mild solution of lukewarm water and universal cleaning detergent. Always wipe with a dry soft cloth after cleaning. For difficult stains such as coffee or tea use a nylon bristle brush with mild household cleaner or detergent, rinsing with clean water and repeating as necessary. Rinse thoroughly with water.

Linoleum

Table tops with linoleum offers a soft touch surface that does not feel as cold and hard as laminate. Regular cleaning is done with a soft cloth wrung in a mild solution of lukewarm water and a universal cleaning detergent. Avoid placing sharp objects on the surface as this may scratch the surface. It is recommended to use trivets or coasters under flowerpots, vases, cups etc.

Marble

The marble plate is made from natural marble and will therefore have variations in structure and colour. This should not be considered a defect nor a valid reason for claims. The marble is treated with a sealer, but it is strongly recommended to use a trivet and never place glasses or cups with liquids directly on to the marble. Spilled liquids will leave permanent stains due to the natural sensitivity of marble. For daily cleaning of the marble top it is recommended to use a cleaning agent specifically developed for stone or marble. It is also highly recommended to do a re-sealing of the marble every second month, using an appropriate sealer developed specifically for stone or marble.

Metal

It is recommended only to use a soft dry cloth to clean plated and powder coated surfaces but in case more severe cleaning is necessary, a soft cloth wrung in lukewarm water can be carefully applied. Always dry immediately after cleaning with a soft dry cloth. Avoid using abrasive cleaning agents or aggressive cleaning detergents on lated or powder coated surfaces as this may permanently damage the surface

Oiled wood

For daily care, dust oiled furniture with a soft dry cloth. Cleaning can be done using a soft cloth wrung in lukewarm water following the wood grain and dried immediately with a dry cloth following the wood grains. For more severe cleaning a soap specifically developed for oiled wood can be used. Follow the instructions on the packaging of the cleaning product. To maintain the look and silky feeling of oiled wood, regular re-oiling is recommended. Re-oiling should be done when the wood starts to appear dry or faded. Usually, reoiling four times every year is sufficient.

Round and square top with wooden legs



Content

- A Table top / round or square
- B Table leg × 3 (up to Ø 90) / × 4 (Ø 91 to Ø 150 cm)
- C Screw × 12 (up to Ø 90) / × 16 (Ø 91 to Ø 150 cm)
- D Allen Key

Unpack the table and ensure all parts pictured are included.

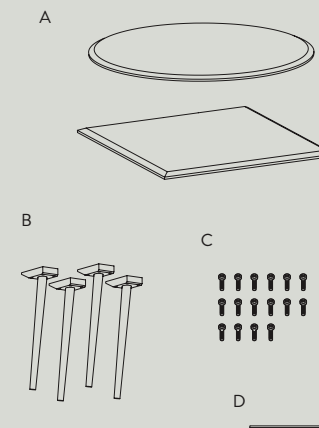

Step 1

Place table top (A) upside down. Please make sure to place table top on soft surface, so that table top will not be damaged during assembly.

Place legs (B) on table top, aligning each leg with all four holes as illustrated.

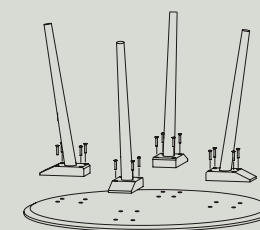

Step 2

Place the screws (C) in the appointed holes and fasten with Allen Key (D).

Repeat the task for the remaining legs.

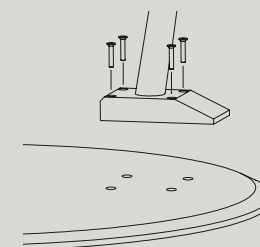

Rectangular top with wooden legs



Content

- A** Table top / with 1 or 2 crossbeams*
- B** Trestle × 2
- C** Barrel nut × 8 (up to 200cm) / × 16 (from 200cm)
- D** Metal dowel × 4 (up to 200cm) / × 8 (from 200cm)
- E** Set screw × 8 (up to 200cm) / × 16 (from 200cm)
- F** Screws × 20
- G** Small Allen key
- H** Large Allen key

Unpack the table and ensure all parts pictured are included.

*Please note that tables up to 200 cm in length have a single crossbeam, while tables of more than 200 cm have two crossbeams beneath the table top.

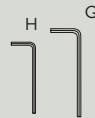
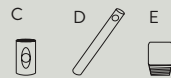
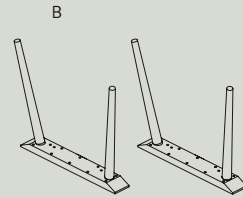
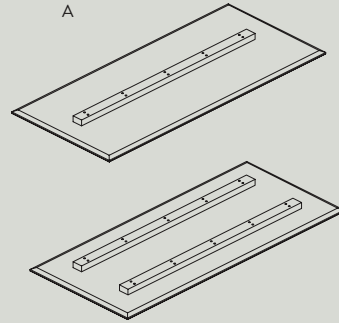

Step 1

Place the table top (A) upside down on a soft, flat surface.

Turn the trestle (B) upside down and align holes with the corresponding holes in crossbeam.

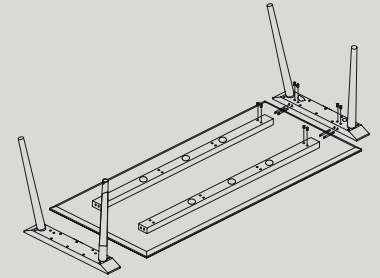

Step 2

Insert barrel nuts (C) (thread side upwards) into the holes in crossbeam and trestle.

Insert metal dowels (D) (coned hole facing up) into corresponding holes.

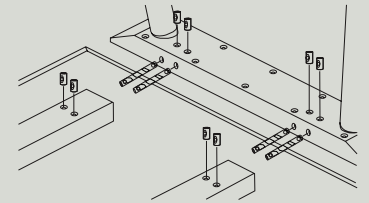

Step 3

Insert set screws (E) into barrel nuts and fasten loosely with large Allen Key (H) so that all parts are held in position but not yet fully tightened.

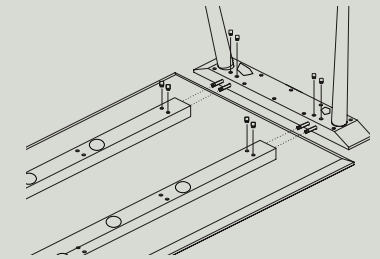

Step 4

Place screws (F) into the appointed holes on the trestle and fasten with small Allen Key (G).

Tighten set screws with large the Allen Key.

Repeat step 1-4 in opposite end of table.

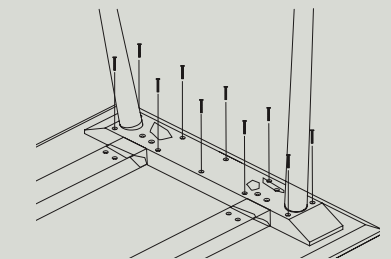

Round and square table top with center base



Content

- A Table top / round or square
- B Top support
- C Column
- D Base
- E Small bolts x 6
- F Large counter sunk bolts x 6
- G Small bolts for marble table top* x 6
- H Allen key x 1
- I Felt pads x 6

Unpack the table and ensure all parts pictured are included.

*Please note that the small bolts (G) shall only be used for the marble table tops - be careful not to overtighten.

Step 1

Place the column (C) on the floor. Place the top support (B) on the column, align the holes with the corresponding holes in the column. Place the large bolts (F) in the appointed holes and fasten clockwise with the large Allen key (H).

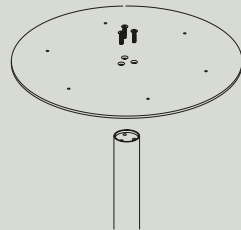
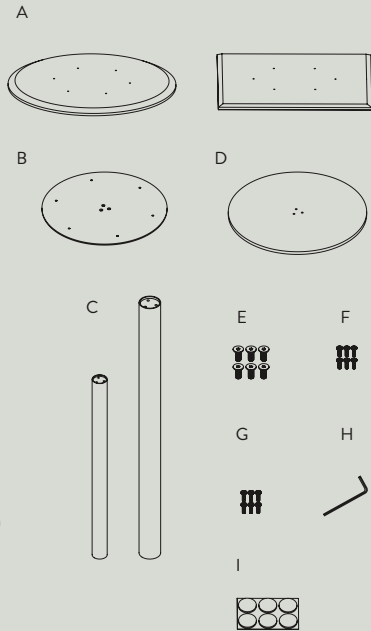

Step 2

Turn the top support upside down on a soft, flat surface.

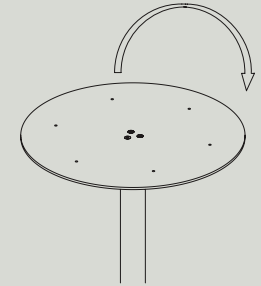

Step 3

Place the base (A) on the column, align the holes with the corresponding holes in the column. Place the large counter sunk bolts (F) in the appointed holes and fasten clockwise with the Allen key (H).

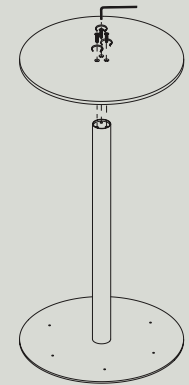

Step 4

Place the felt pads (I) on the bottom of the base, with equal spacing and 2 cm from the edge as illustrated.

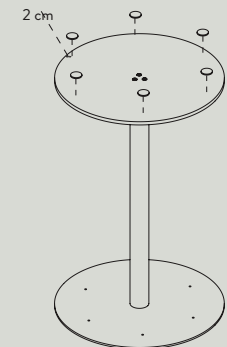

Step 5

Turn the base upside down and place carefully on the floor.

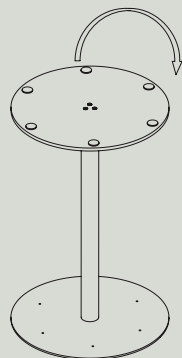

Step 6

Place the table top (A) on top of the top support. Align the holes with the corresponding holes in the table top. Choose the correct screw depending on the table top. The shortest is for marble table tops and the longest is for all other table tops. Place the flanged button head screws (E)(G) in the appointed holes and fasten clockwise with the Allen key (H).

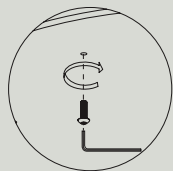
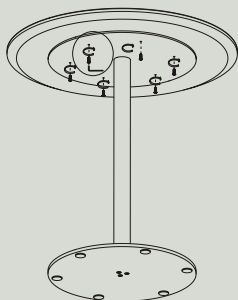

Rectangular tables

Rectangular tables need two bases. Please follow the previous instruction steps 1-6 on how to assemble each of the bases.

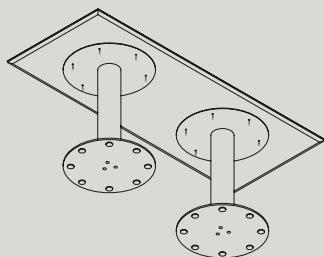

Round and square top with center base



Content

- A Table top
- B Top support
- C Column
- D Base
- E Small bolts x 6
- F Small bolts for marble table top* x 6
- G Large counter sunk bolts x 3
- H Large counter sunk bolts x 4
- I Small Allen key x 1
- J Medium Allen key x 1
- K Large Allen key x 1
- L Felt pads x 6

Unpack the table and ensure all parts pictured are included.

*Please note that that small bolts (F) shall only be used for the marble table tops - be careful not to overtighten.

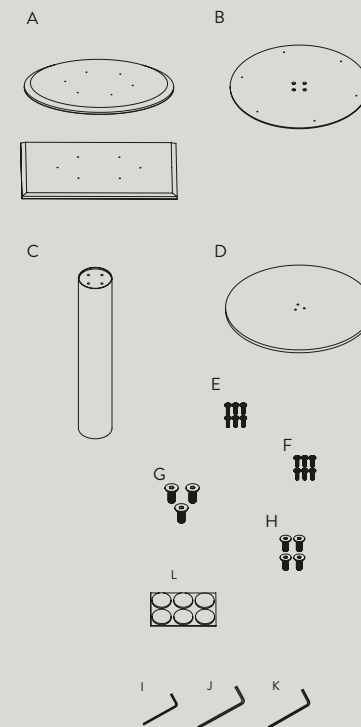

Step 1

Place the column (C) on the floor. Place the top support (B) on the column, align the holes with the corresponding holes in the column. Place the large bolts (H) in the appointed holes and fasten clockwise with the large Allen key (K).

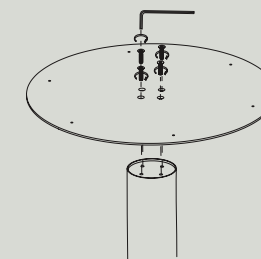

Step 2

Turn the top support upside down on a soft, flat surface.

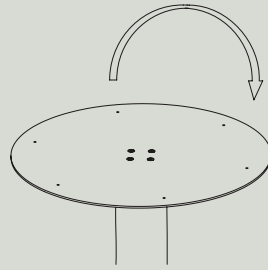

Step 3

Place the base (D) on the column, align the holes with the corresponding holes in the column. Place the large counter sunk bolts (G) in the appointed holes and fasten clockwise with the Allen key (J).

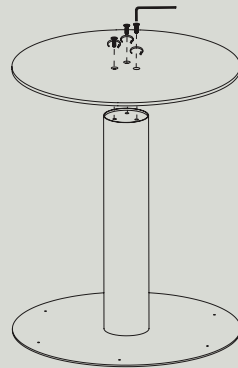

Step 4

Place the felt pads (L) on the bottom of the base, with equal spacing and 2 cm from the edge as illustrated.

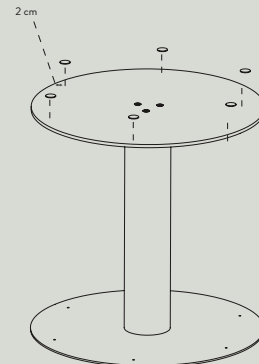

Step 5

Turn the base upside down and place carefully on the floor.

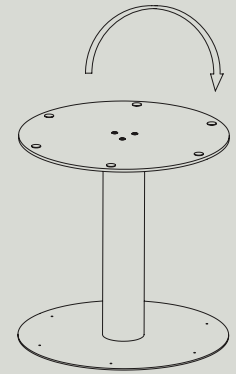

Step 6

Place the table top (A) on top of the top support. Align the holes with the corresponding holes in the table top. Choose the correct screw depending on the table top. The shortest is for marble table tops and the longest is for all other table tops. Place the flanged button head screws (E)(F) in the appointed holes and fasten clockwise with the Allen key (I).

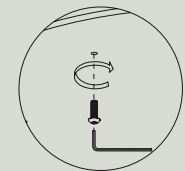
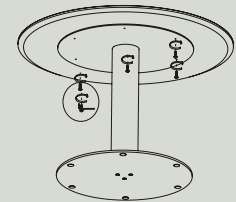

Rectangular tables

Rectangular tables need two bases. Please follow the previous instruction steps 1-6 on how to assemble each of the bases.

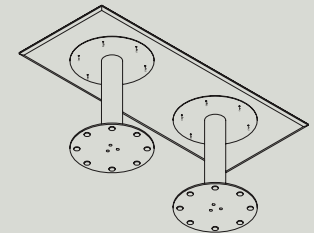

&Tradition®