

Audo

COPENHAGEN



EAVE SEAMLINER MODULAR SOFA, 85
Designed by *Norm Architects*

EAVE SEAMLINE 86, OPEN SECTION & CORNER
Designed by *Norm Architects*

The result of a collaboration between Audo Copenhagen and Norm Architects, the Eave Collection of module sofas allows for total customisation of living and lounge spaces thanks to comfortable and generously proportioned corner, open end and chaise longue segments in softly minimal silhouettes.

PRODUCT OPTIONS

Open Section



Corner



Spec options

Available in fabrics from our upholstery programme. Standard lead times apply.

For custom upholstery, please refer to the guiding textile/leather consumption:
COM: 3,6 m / 3,93 yds

Prices excl. custom upholstery are equal to Price Category 1 Textile or Leather. Contact sales support to place your order.

The above textile consumption is only valid for textile rolls with a width equal to or greater than 140 cm. For smaller textile rolls, please contact Sales Support for guidance. For textile with pattern, please expect a higher usage for correct pattern fitting. Please contact Sales Support for guidance.

TECHNICAL SPECIFICATIONS

PRODUCT TYPE
Sofa

COLLI
1

ENVIRONMENT
Indoor

DIMENSIONS

Open Section
H: 71 cm / 27,9"
W: 86 cm / 33,86"
D: 86 cm / 33,86"
SD: 56 cm / 22,05"
SH: 40,5 cm / 15,94"

Corner
H: 71 cm / 27,9"
W: 86 cm / 33,86"
D: 86 cm / 33,86"
SD: 56 cm / 22,05"
SH: 40,5 cm / 15,94"

PRODUCTION PROCESS
Each module is constructed with a structural frame made from chipboard, plywood and solid wood. Seat, backrest and armrests consist of a double foam layer with no-sag springs.

COLOUR
Dependent upon selected upholstery
Black glides (RAL 9005)

GLOSS
N / A

MATERIALS

Seat
Pine, plywood, MDF, steel (spring), HR
Foam and upholstery

Glides and connector
Plastic, steel, felt

WEIGHT
N / A

WARRANTY
10 Years

CORNER VARIANTS
Corner modules come in left and right variants according to fabric weave direction. Please ensure you select the correct one for your needs.

PACKAGING TYPE
Brown box

PACKAGING MEASUREMENTS
(H x W x D)
N / A

MATERIALS & MAINTENANCE
Please visit audocph.com for materials, care and maintenance instructions.

OPEN SECTION

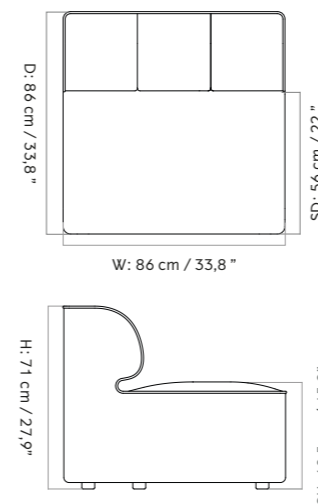

CORNER

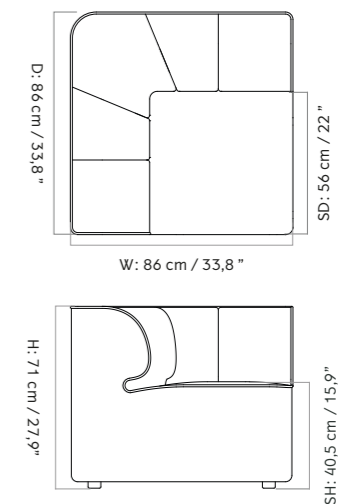

EAVE SEAMLINE 86, CONCAVE OPEN SECTION & CORNER
Designed by *Norm Architects*

The result of a collaboration between Audo Copenhagen and Norm Architects, the Eave Collection of module sofas allows for total customisation of living and lounge spaces thanks to comfortable and generously proportioned corner, open end and chaise longue segments in softly minimal silhouettes.

PRODUCT OPTIONS

Concave Open Section



Concave Corner



Spec options

Available in fabrics from our upholstery programme.
Standard lead times apply.

For custom upholstery, please refer to the guiding
textile/leather consumption:
COM: 3,8 m / 4,15 yds

Prices excl. custom upholstery are equal to Price Category 1
Textile or Leather. Contact sales support to place your order.

The above textile consumption is only valid for textile rolls with a width equal to
or greater than 140 cm. For smaller textile rolls, please contact Sales Support for
guidance. For textile with pattern, please expect a higher usage for correct pattern
fitting. Please contact Sales Support for guidance.

TECHNICAL SPECIFICATIONS

PRODUCT TYPE
Sofa

COLLI
1

ENVIRONMENT
Indoor

DIMENSIONS

Concave Open Section
H: 71 cm / 27,95"
W: 141 cm / 55,51"
D: 126 cm / 49,61"
SD: 56 cm / 22,05"
SH: 40,5 cm / 15,94"

Concave Corner
H: 71 cm / 27,9"
W: 86 cm / 33,86"
D: 86 cm / 33,86"
SD: 56 cm / 22,05"
SH: 40,5 cm / 15,94"

PRODUCTION PROCESS
Each module is constructed with a
structural frame made from chipboard,
plywood and solid wood. Seat, backrest and
armrests consist of a double foam layer
with no-sag springs.

COLOUR
Dependent upon selected upholstery
Black glides (RAL 9005)

GLOSS
N / A

MATERIALS

Seat
Pine, plywood, MDF, steel (spring), HR
Foam and upholstery

Glides and connector
Plastic, steel, felt

WEIGHT
N / A

WARRANTY
10 Years

CORNER VARIANTS
Corner modules come in left and right
variants according to fabric weave
direction. Please ensure you select the
correct one for your needs.

PACKAGING TYPE
Brown box

PACKAGING MEASUREMENTS
(H x W x D)
N / A

MATERIALS & MAINTENANCE
Please visit audocph.com for materials, care
and maintenance instructions.

CONCAVE OPEN SECTION

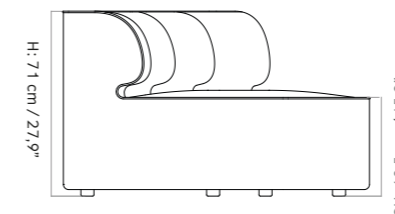
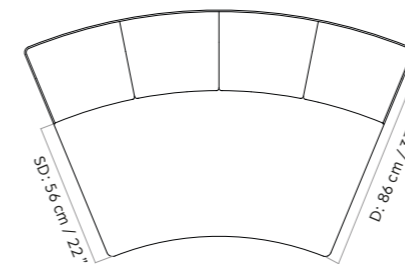

CONCAVE CORNER

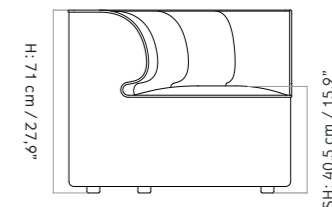
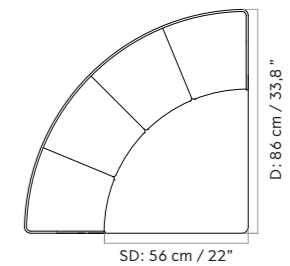

EAVE SEAMLINE 86, CONVEX OPEN SECTION & CORNER
Designed by *Norm Architects*

The result of a collaboration between Audo Copenhagen and Norm Architects, the Eave Collection of module sofas allows for total customisation of living and lounge spaces thanks to comfortable and generously proportioned corner, open end and chaise longue segments in softly minimal silhouettes.

PRODUCT OPTIONS

Convex Open Section



Convex Corner



Spec options

Available in fabrics from our upholstery programme.
Standard lead times apply.

For custom upholstery, please refer to the guiding
textile/leather consumption:
COM: 3,4 m / 4,71 yds

Prices excl. custom upholstery are equal to Price Category 1
Textile or Leather. Contact sales support to place your order.

The above textile consumption is only valid for textile rolls with a width equal to
or greater than 140 cm. For smaller textile rolls, please contact Sales Support for
guidance. For textile with pattern, please expect a higher usage for correct pattern
fitting. Please contact Sales Support for guidance.

TECHNICAL SPECIFICATIONS

PRODUCT TYPE
Sofa

COLLI
1

ENVIRONMENT
Indoor

DIMENSIONS

Convex Open Section
H: 71 cm / 27,95"
W: 141 cm / 55,51"
D: 86 cm / 33,86"
SD: 56 cm / 22,05"
SH: 40,5 cm / 15,94"

Convex Corner
H: 71 cm / 27,95"
W: 86 cm / 33,86"
D: 86 cm / 33,86"
SD: 56 cm / 22,05"
SH: 40,5 cm / 15,94"

PRODUCTION PROCESS
Each module is constructed with a
structural frame made from chipboard,
plywood and solid wood. Seat, backrest and
armrests consist of a double foam layer
with no-sag springs.

COLOUR
Dependent upon selected upholstery
Black glides (RAL 9005)

GLOSS
N / A

MATERIALS

Seat
Pine, plywood, MDF, steel (spring), HR
Foam and upholstery

Glides and connector
Plastic, steel, felt

WEIGHT
N / A

WARRANTY
10 Years

CORNER VARIANTS
Corner modules come in left and right
variants according to fabric weave
direction. Please ensure you select the
correct one for your needs.

PACKAGING TYPE
Brown box

PACKAGING MEASUREMENTS
(H x W x D)
N / A

MATERIALS & MAINTENANCE
Please visit audocph.com for materials, care
and maintenance instructions.

CONVEX OPEN SECTION

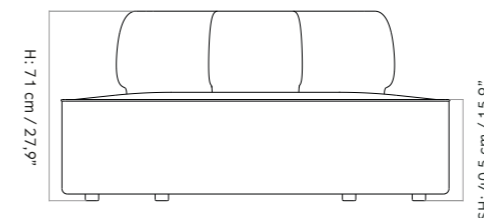
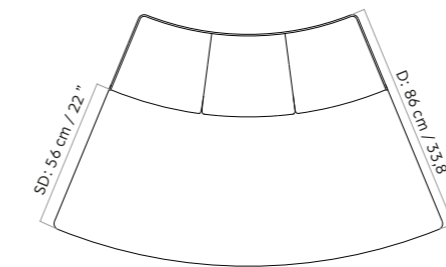

CONVEX CORNER

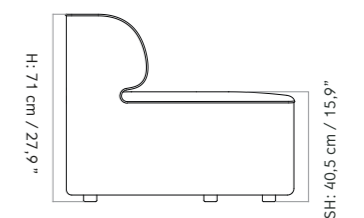
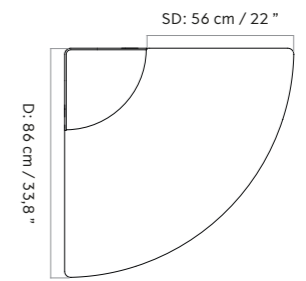

EAVE SEAMLINE 86, OPEN SECTION & CORNER 172
Designed by *Norm Architects*

The result of a collaboration between Audo Copenhagen and Norm Architects, the Eave Collection of module sofas allows for total customisation of living and lounge spaces thanks to comfortable and generously proportioned corner, open end and chaise longue segments in softly minimal silhouettes.

PRODUCT OPTIONS

Open Section 172



Corner 172



Spec options

Available in fabrics from our upholstery programme.
Standard lead times apply.

For custom upholstery, please refer to the guiding
textile/leather consumption:
COM: 3,4 m / 4,71 yds

Prices excl. custom upholstery are equal to Price Category 1
Textile or Leather. Contact sales support to place your order.

The above textile consumption is only valid for textile rolls with a width equal to
or greater than 140 cm. For smaller textile rolls, please contact Sales Support for
guidance. For textile with pattern, please expect a higher usage for correct pattern
fitting. Please contact Sales Support for guidance.

TECHNICAL SPECIFICATIONS

PRODUCT TYPE
Sofa

COLLI
1

ENVIRONMENT
Indoor

DIMENSIONS

Open Section 172
H: 71 cm / 27,95"
W: 172 cm / 67,72"
D: 86 cm / 33,86"
SD: 56 cm / 22,05"
SH: 40,5 cm / 15,94"

Corner 172
H: 71 cm / 27,95"
W: 172 cm / 67,72"
D: 86 cm / 33,86"
SD: 56 cm / 22,05"
SH: 40,5 cm / 15,94"

PRODUCTION PROCESS
Each module is constructed with a
structural frame made from chipboard,
plywood and solid wood. Seat, backrest and
armrests consist of a double foam layer
with no-sag springs.

COLOUR
Dependent upon selected upholstery
Black glides (RAL 9005)

GLOSS
N / A

MATERIALS

Seat
Pine, plywood, MDF, steel (spring), HR
Foam and upholstery

Glides and connector
Plastic, steel, felt

WEIGHT
N / A

WARRANTY
10 Years

CORNER VARIANTS
Corner modules come in left and right
variants according to fabric weave
direction. Please ensure you select the
correct one for your needs.

PACKAGING TYPE
Brown box

PACKAGING MEASUREMENTS
(H x W x D)
N / A

MATERIALS & MAINTENANCE
Please visit audocph.com for materials, care
and maintenance instructions.

OPEN SECTION 172

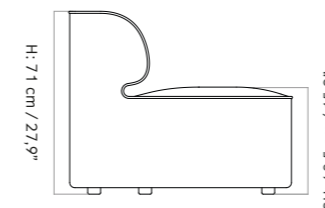
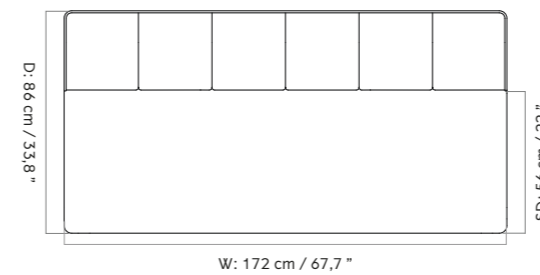

CORNER 172

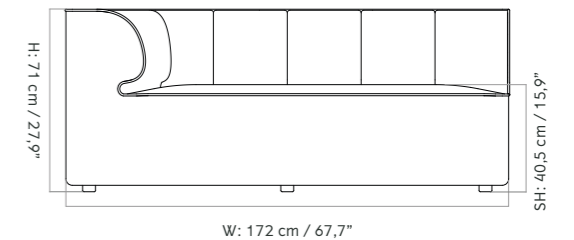
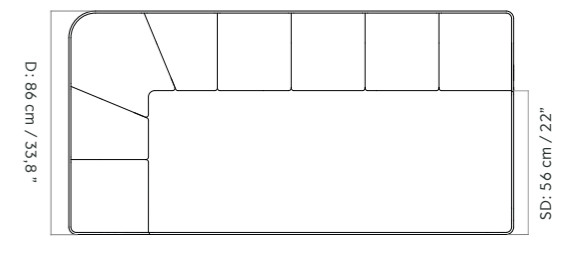

The result of a collaboration between Audo Copenhagen and Norm Architects, the Eave Collection of module sofas allows for total customisation of living and lounge spaces thanks to comfortable and generously proportioned corner, open end and chaise longue segments in softly minimal silhouettes.

PRODUCT OPTIONS

Chaise Longue



Spec options

Available in fabrics from our upholstery programme. Standard lead times apply.

For custom upholstery, please refer to the guiding textile/leather consumption:
 COM: 3,4 m / 4,71 yds

Prices excl. custom upholstery are equal to Price Category 1 Textile or Leather. Contact sales support to place your order.

The above textile consumption is only valid for textile rolls with a width equal to or greater than 140 cm. For smaller textile rolls, please contact Sales Support for guidance. For textile with pattern, please expect a higher usage for correct pattern fitting. Please contact Sales Support for guidance.

PRODUCT TYPE
 Sofa

COLLI
 1

ENVIRONMENT
 Indoor

DIMENSIONS
 H: 71 cm / 27,95"
 W: 142 cm / 55,9"
 D: 86 cm / 33,86"
 SD: 56 cm / 22,05"
 SH: 40,5 cm / 15,94"

PRODUCTION PROCESS
 Each module is constructed with a structural frame made from chipboard, plywood and solid wood. Seat, backrest and armrests consist of a double foam layer with no-sag springs.

TECHNICAL SPECIFICATIONS

COLOUR
 Dependent upon selected upholstery
 Black glides (RAL 9005)

GLOSS
 N / A

MATERIALS

Seat
 Pine, plywood, MDF, steel (spring), HR
 Foam and upholstery

Glides and connector
 Plastic, steel, felt

WEIGHT
 N / A

WARRANTY
 10 Years

CORNER VARIANTS
 Corner modules come in left and right variants according to fabric weave direction. Please ensure you select the correct one for your needs.

PACKAGING TYPE
 Brown box

PACKAGING MEASUREMENTS
 (H x W x D)
 N / A

MATERIALS & MAINTENANCE
 Please visit audocph.com for materials, care and maintenance instructions.

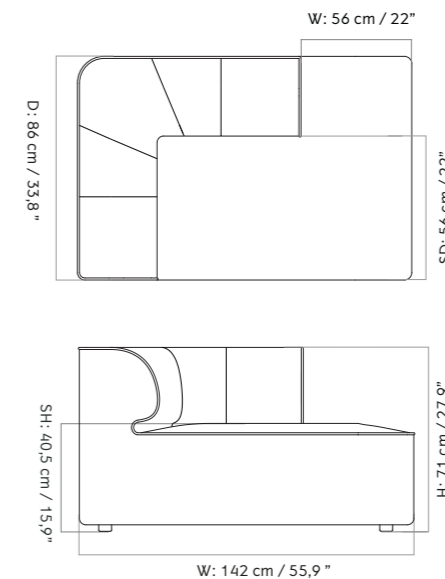

The result of a collaboration between Audo Copenhagen and Norm Architects, the Eave Collection of module sofas allows for total customisation of living and lounge spaces thanks to comfortable and generously proportioned corner, open end and chaise longue segments in softly minimal silhouettes.

PRODUCT OPTIONS

Chaise Longue



Spec options

Available in fabrics from our upholstery programme. Standard lead times apply.

For custom upholstery, please refer to the guiding textile/leather consumption:
 COM: 3,4 m / 4,71 yds

Prices excl. custom upholstery are equal to Price Category 1 Textile or Leather. Contact sales support to place your order.

The above textile consumption is only valid for textile rolls with a width equal to or greater than 140 cm. For smaller textile rolls, please contact Sales Support for guidance. For textile with pattern, please expect a higher usage for correct pattern fitting. Please contact Sales Support for guidance.

PRODUCT TYPE
 Sofa

COLLI
 1

ENVIRONMENT
 Indoor

DIMENSIONS
 H: 71 cm / 27,95"
 W: 142 cm / 55,9"
 D: 86 cm / 33,86"
 SD: 56 cm / 22,05"
 SH: 40,5 cm / 15,94"

PRODUCTION PROCESS
 Each module is constructed with a structural frame made from chipboard, plywood and solid wood. Seat, backrest and armrests consist of a double foam layer with no-sag springs.

TECHNICAL SPECIFICATIONS

COLOUR
 Dependent upon selected upholstery
 Black glides (RAL 9005)

GLOSS
 N / A

MATERIALS

Seat
 Pine, plywood, MDF, steel (spring), HR
 Foam and upholstery

Glides and connector
 Plastic, steel, felt

WEIGHT
 N / A

WARRANTY
 10 Years

CORNER VARIANTS
 Corner modules come in left and right variants according to fabric weave direction. Please ensure you select the correct one for your needs.

PACKAGING TYPE
 Brown box

PACKAGING MEASUREMENTS
 (H x W x D)
 N / A

MATERIALS & MAINTENANCE
 Please visit audocph.com for materials, care and maintenance instructions.

