

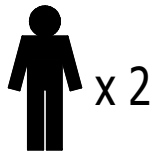

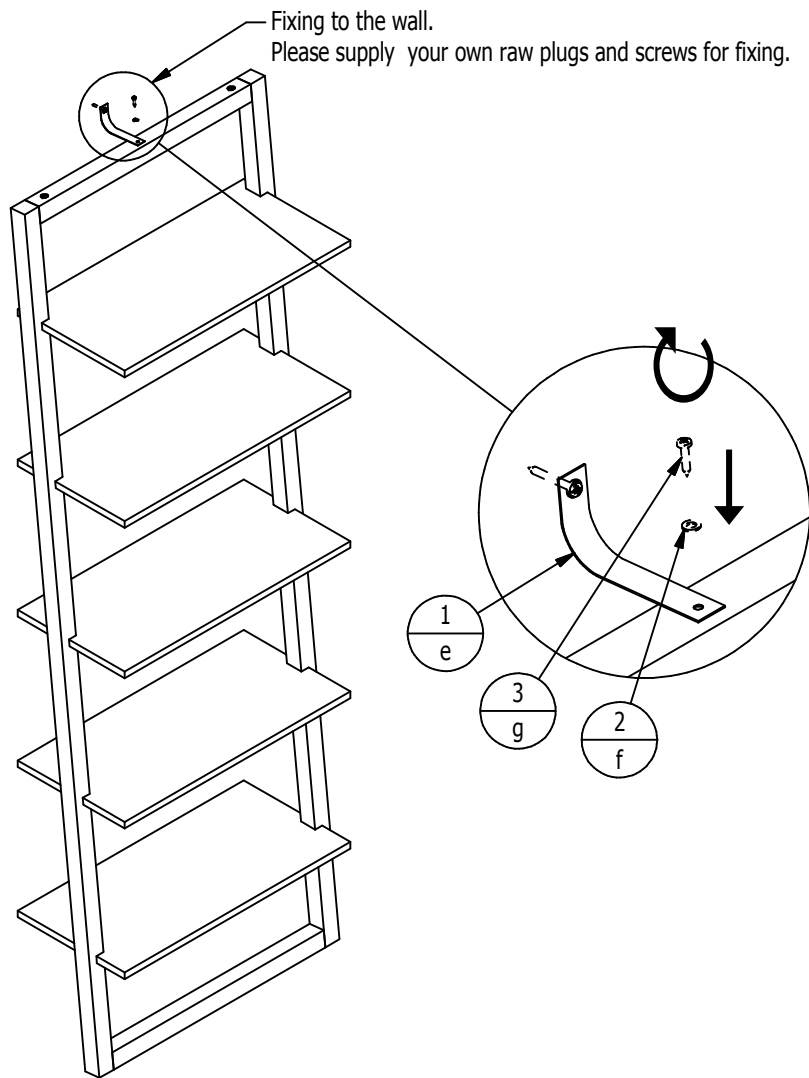



# Assembly instruction

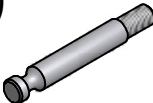
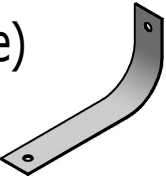

a)  x 12	f)  x 2
b)  x 6	g)  x 1
c)  x 6	
d)  x 6	
e)  x 1	
