

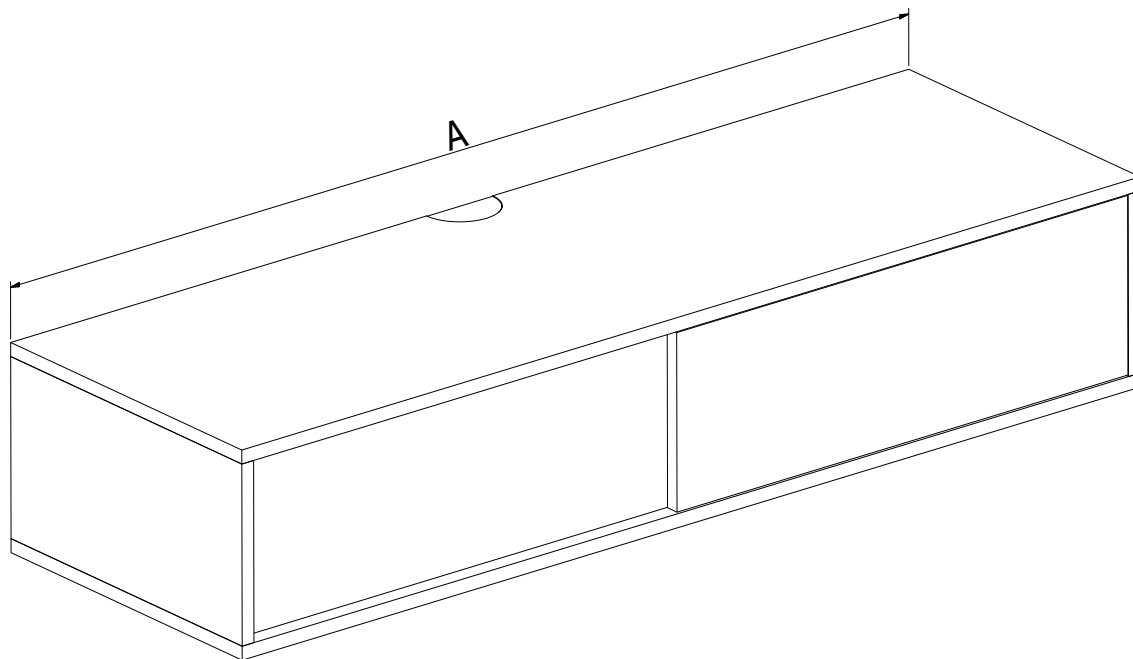

SCARPI ADJUSTMENT INSTRUCTION

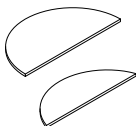

A					 x 2	 +   
1220	x1	x1	x1	x4		
1360		x2	x2	x8		
1800						

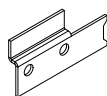
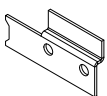
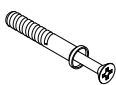
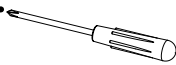
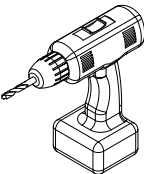
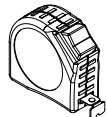