

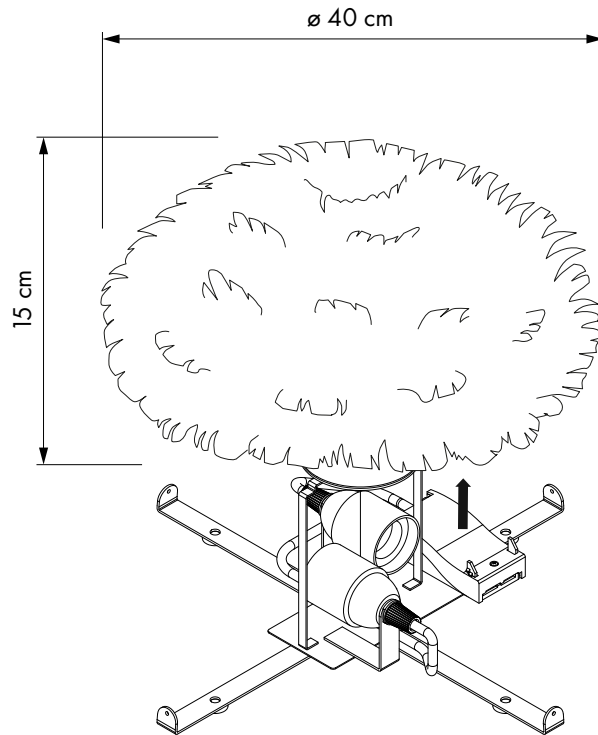

# UMAGE Eos Up

#2140









Designed by Soren Ravn Christensen in Copenhagen, Denmark



## Colour variations



White

	<b>Ceiling and wall in one</b>
	<b>Dimensions</b> ø 40 cm h 15 cm
	<b>Material</b> Goose feathers , fabric and steel
	<b>Easily cleaned with hairdryer</b>
	<b>Weight incl. packaging</b> 1300 g
	<b>Light source</b> 2 x E27 - max 15 W LED Bulb recommendation: #4136 or #4026
	<b>Packaging</b> Gift Box, Dimensions (W×H×D): 38.5 x 14.5 x 38.5 cm
	<b>Assembly time</b> 15 min - video guide at <a href="http://umage.com">umage.com</a>
	<b>CE certified</b> For indoor use
	<b>Media Kit</b> Photos, 3D models Download at <a href="http://umage.com">umage.com</a>

# **Ordering Information**  
Eos Up white #2140

**Accessories**  
Idea 6W 60 mm LED bulb #4026  
Idea 13W 70 mm LED bulb #4136

 **Download the UIMAGE Unfold at Home App**  
It helps you choose the perfect lamp

UNFOLD  
AT HOME

